



VPP50 Vacuum Pickup System Operating Manual

info@fisnar.com

www.fisnar.com

Table of Contents

Machine Overview	3
Product Safety Statements	4
Specifications	6
Accessories	6
External Controls	7
Machine Setup	10
Vacuum Pickup Pen Setup	11
Operation Mode	12
External Machine Actuation	13
Spare Parts List	14

OVERVIEW



Model VPP50 Vacuum Pick System

The VPP50 Vacuum Pickup System is designed for safely and efficiently picking up and placing delicate lightweight components with ease. Unlike conventional tweezers, the use of a rubber suction cup prevents possible accidental damage or contamination to the component during the lifting and positioning process.

Its simple pneumatic only control and easy to use finger actuated design; allows the system to be used in workspace environments, where electrical supply is not available or not permitted.

Operation Mode

- 1.) The component is lifted by lightly placing the suction cup on the component.
- 2.) The operator's finger is then positioned over the hole on the finger grip of the vacuum pickup pen and kept held down to apply the vacuum through the suction cup.
- 3.) This then allows the component to be picked up and safely positioned.
- 4.) The operator's finger can then be removed from the hole on the finger grip, which stops the vacuum, allowing safe release of the component.

Compliant for use in ESD safe environments

Simple set-up and operation

Manually finger actuated design

Adjustable vacuum control

Pneumatic only system, allows it to be used in workspace environments where electrical supply is not available or not permitted

Lightweight ergonomic pickup pen included







Compact & durable aluminum housing designed for industrial work environments.

Stand included for safe storage of vacuum pick-up pen when not in use.

A selection of ESD safe tips and vacuum cups included to ensure compatibility with differing applications

SAFETY

General Precautions

	<i>Do not operate the machine in excess of its maximum ratings / settings.</i>
	<i>Make sure that the input air supply is clean and dry. A 5 micron air filter/regulator (item number 560567) is recommended to ensure the input air supply is clean and dry.</i>
	<i>Do not smoke or use near an open flame.</i>
	<i>Do not expose the machine directly to sunlight.</i>
	<i>Avoid cleaning the machine with aggressive solvents – neutral detergents are preferred.</i>
	<i>Place the vacuum pickup pen in the supplied holder when not using the machine. This will prevent the suction cup from being damaged – refer to figure A below.</i>

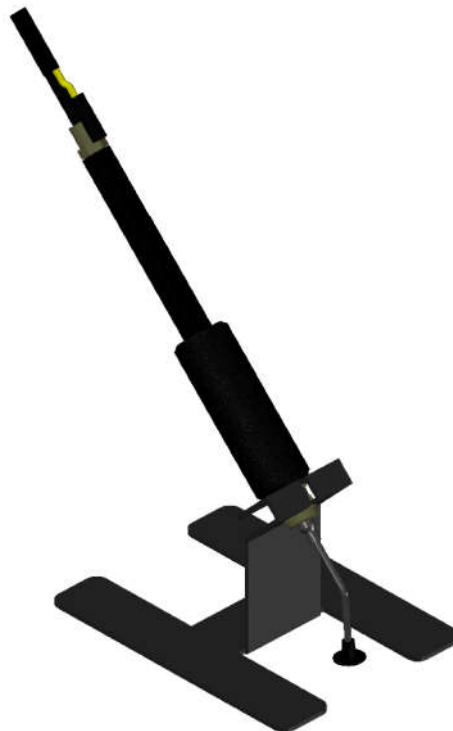



Fig. A

VPP50 Malfunction

	<i>If the machine malfunctions, shut down the machine immediately. This can be done by shutting off the compressed air supply connected to the air input connector on the back of the machine.</i>
---	--

SAFETY

Inappropriate Use

If the machine is used in a way other than described in this manual, it may cause damage to self or property.



Do not use any components with the machine other than Fisnar authorized components.



Do not use incompatible materials.



***Do not make any modifications to the machine.
All repairs are to be done using Fisnar specified spare parts.***



Do not operate the machine in excess of its maximum ratings / settings.

Fire Prevention

Refer to the following instructions to avoid any fire or explosion.



Assess your surroundings and the location of the nearest fire extinguisher and Emergency Exit.



Do not smoke or use near an open flame.



Do not expose the machine directly to sunlight.

Maintenance

The VPP50 is generally a maintenance free machine. However, to ensure smooth operation please follow the below instructions.



Only use non-woven cleaners on the machine.



Avoid cleaning the machine with aggressive solvents – neutral detergents are preferred.



Ensure that compressed air supply to the machine is clean and moisture free.



Place the vacuum pickup pen in the supplied holder when not using the machine. This will prevent the suction cup from being damaged.

SPECIFICATIONS

Dimensions (W x D x H):	3.78" x 5.04" x 3.00" (96 x 128 x 76 mm)
Weight:	0.84 lbs (0.38 kg)
Relative Humidity:	20 – 90% (No Condensation)
Operating Temperature:	50 – 104°F (10 – 40°C)
Air Input:	100 psi (7 bar) max
Vacuum:	Up to 400 mm-Hg (15.75in.-Hg)
Maximum Pickup Weight	Up to 4.4oz (125g)
Standards:	RoHS Compliant, ESD Safe

ACCESSORIES

Item	Description	Quantity
561851	Air Inlet Hose Assembly	1
5601947	ESD Grounding Cable Assembly	1
5601948	Vacuum Pickup Pen Holder	1
580046-ESD	Vacuum Pickup Pen – ESD Safe	1
QK-VTK	Vacuum Tip Kit	1

Note: Standard Vacuum Pickup Pen (part # 580046) & ESD Workstation kit (part # ESD-WSK-US / ESD-WSK-EU / ESD-WSK-UK) available to purchase separately.



Part # 580046



Part # ESD-WSK-US
Part # ESD-WSK-EU
Part # ESD-WSK-UK

EXTERNAL CONTROLS

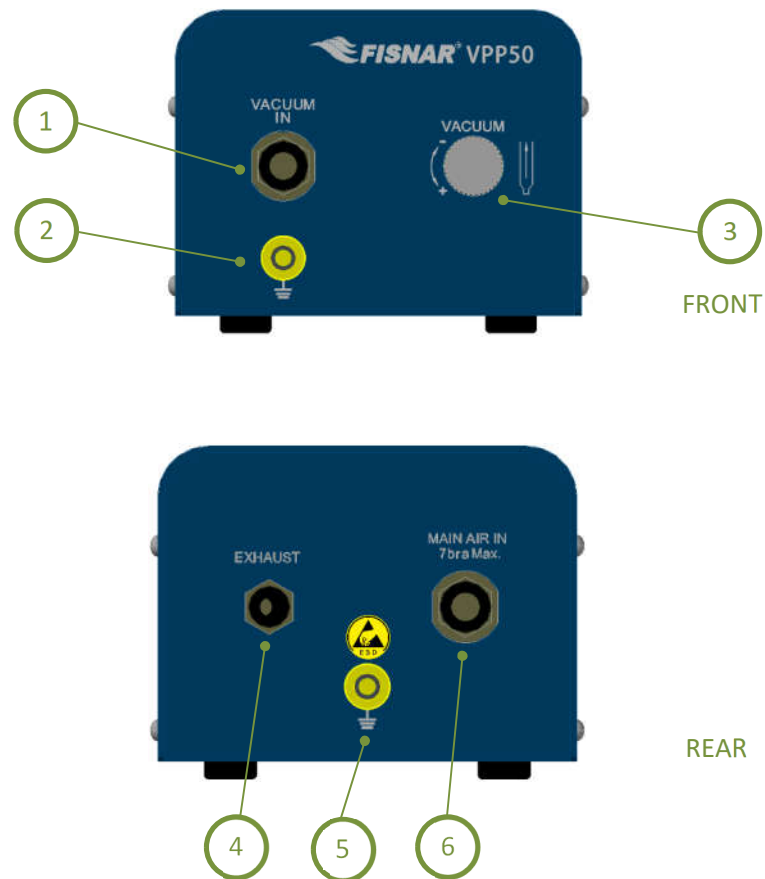

FIG. 1: External Controls – Overview

Item	Illustration	Item	Illustration
1	Vacuum Inlet Port	5	ESD Grounding Point
2	ESD Input Connector	6	Air Inlet Port
3	Vacuum Control		
4	Exhaust Port		

EXTERNAL CONTROLS

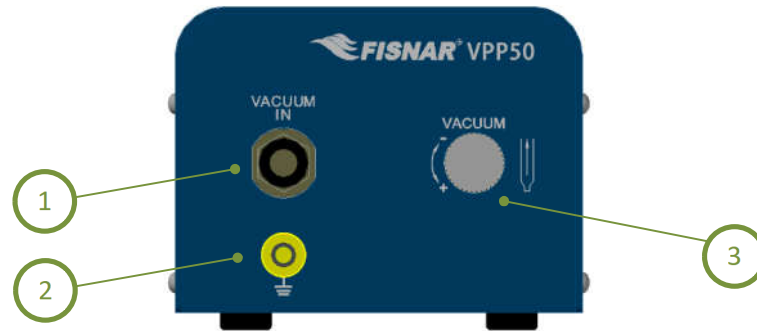

FIG. 2: External Controls – Front

1.	Vacuum Inlet Port	The air connector on the vacuum pickup pen is connected here.
2.	ESD Input Connector	The electrical plug on the vacuum pickup pen is connected here. <i>This does not apply if using optional vacuum pickup pen (#580046).</i>
3.	Vacuum Control	Adjusts the amount of vacuum pressure being used, for the suction cup to safely and securely pick up the component. Turn the knob counterclockwise to increase the vacuum pressure to the desired level. <i>Vacuum pressure will not be generated until the foot pedal has been pressed.</i>

EXTERNAL CONTROLS

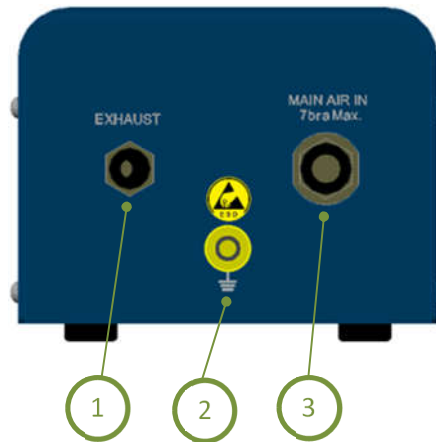

FIG. 3: External Controls - Back

1.	Exhaust	<p>When the machine is in use, air will be exhausted from this connector.</p> <p>A muffler (#560024) can be fitted into the exhaust outlet port to reduce the emitted noise of the exhausted air.</p>
2.	ESD Grounding Point	<p>ESD grounding cable (#5601947) is connected here. The other end of the cable is to be connected to a suitable common ESD Safe grounding point within the workplace environment.</p>
3.	Air In Push Connector	<p>External Compressed air 70-100 psi (5-7 bar) is to be connected here, using the supplied 1/4" OD air inlet hose.</p>

MACHINE SET UP

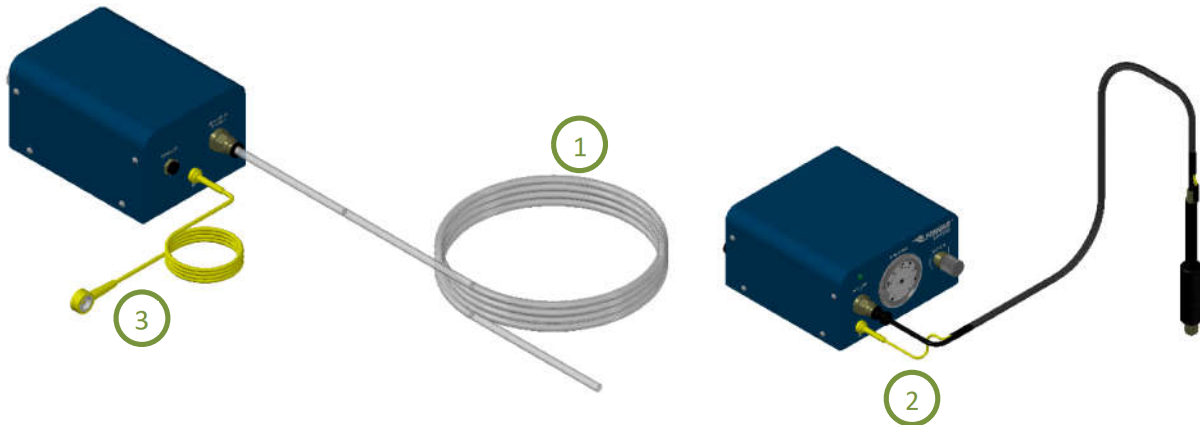

FIG. 4: Machine Setup

1.	Connect air hose (1) from compressed air 70-100 psi (5-7 bar) to the air inlet port on the back of the machine. See FIG. 4.
2.	<p>Insert the air connector and ESD grounding plug (2) from the vacuum pickup pen to the ports on the front of the machine. See FIG. 4.</p> <p><i>If using optional vacuum pickup pen (#580046) only the air connector will need to be attached to the port on the front of the machine.</i></p>
3.	<p>Insert the ESD grounding cable (3) into the port on the back of the machine. The other end of the cable is to be connected to a suitable common ESD Safe grounding point within the workplace environment. See FIG. 4.</p> <p><i>If there is no requirement for the machine to be used in an ESD Safe work environment, this step can be ignored.</i></p>

VACUUM PICKUP PEN SETUP

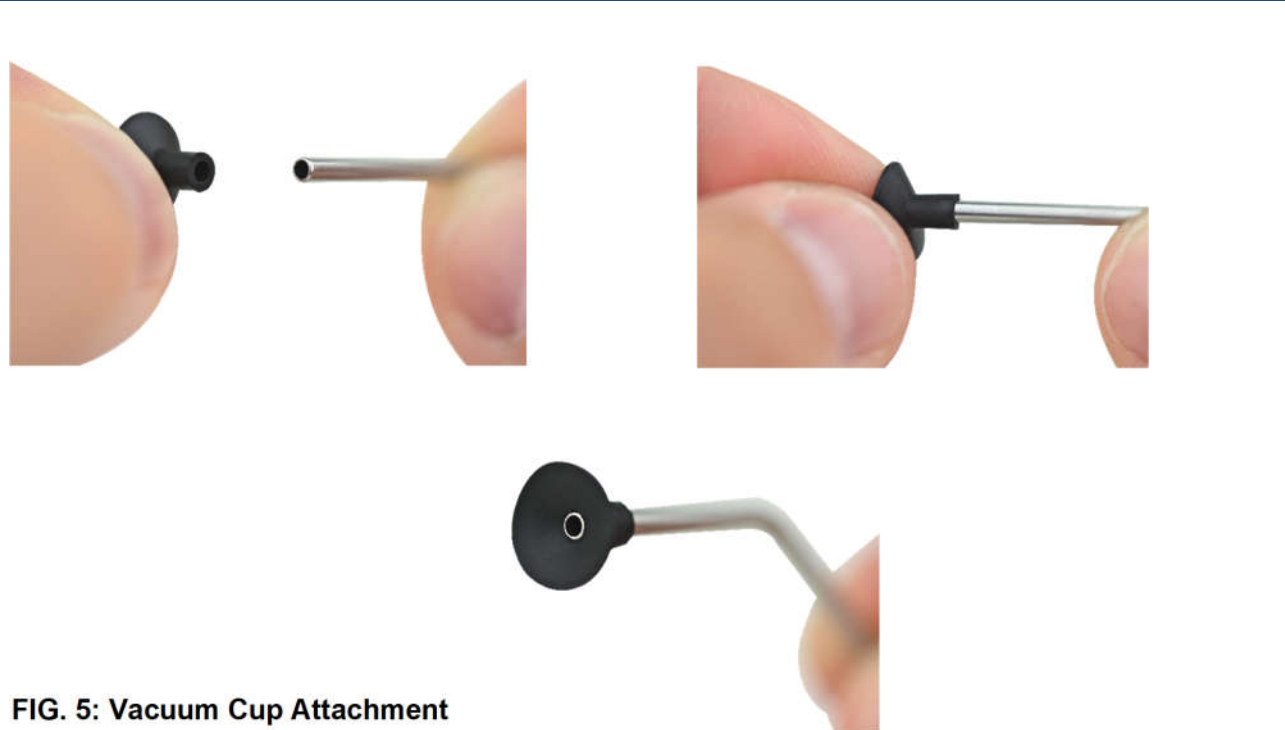

FIG. 5: Vacuum Cup Attachment

1.	Select the correct size vacuum cup based on the size and weight of the component to be picked up.
2.	Select the correct size pickup tip, by choosing one which has a larger outside diameter, than the internal hole on the stem of the chosen vacuum cup.
3.	<p>Gently push the stem of the vacuum cup onto the pickup tip. See FIG. 5.</p> <p>Ensure that the pickup tip does not protrude into the “cup” area of the vacuum cup, as this may result in damaging the component that is to be picked up.</p> <p>A successful setup will be confirmed by a tight fit that does not deform the surface of the vacuum cup.</p>
4.	Insert the pickup tip assembly into the pickup pen, until pickup tip hub is fully secured. If using a 45° pickup tip, rotate the tip to achieve the correct pickup angle position.
5.	Store the pickup pen into the supplied holder, to prevent the vacuum cup from being damaged when not in use.

OPERATION MODE

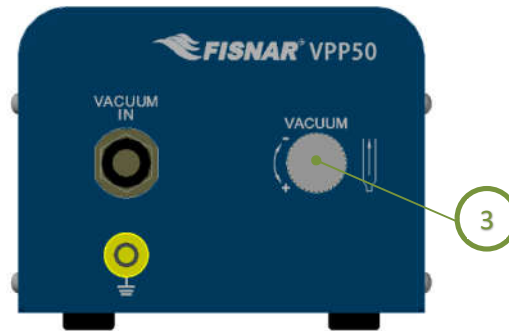
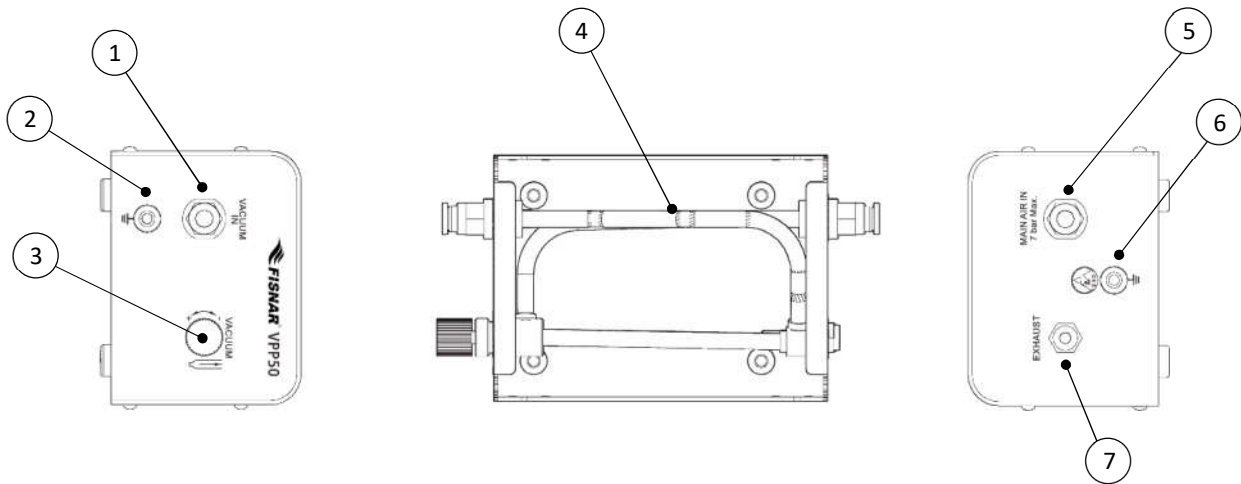

FIG. 6: Operation Mode

1.	Place the suction cup installed on the pick-up pen over the component and apply a light force so there is no gap between the surface of the suction cup and surface of the component.
2.	Position finger over the hole on the finger grip of the vacuum pickup pen and keep held down to apply the vacuum through the suction cup.
3.	<p>Use the vacuum control knob to increase the vacuum pressure by slowly turning it counterclockwise to a suitable level where there is enough force to securely seal the suction cup to the component. See FIG. 6.</p> <p style="color: red;">This step is only required when initially setting up the machine.</p> <p style="color: red;">Excessive vacuum pressure may cause damage to small delicate components. Always use minimum allowable vacuum pressure.</p>
3.	The component can now be picked up and safely positioned in the desired location.
4.	Remove finger away from the hole on the finger grip of the vacuum pickup, and then remove the suction cup safely away from the component.

SPARE PARTS LIST



Ref.	Item Number	Description
1	5601940	Air In/Out Module
2	5601946	ESD Socket Assembly
3	5601941	Vacuum Control Valve (inc. fittings)
4	5601887-10FT	Ø6mm Transparent PU Tubing (10ft)
5	5601940	Air In/Out Module
6	5601946	ESD Socket Assembly
7	5601906	Vacuum Transducer (inc. fittings)
8*	561851	Air Inlet Hose Assembly
9*	5601947	ESD Grounding Cable Assembly
10*	5601948	Vacuum Pickup Pen Holder
11*	580046-ESD	Vacuum Pickup Pen (VPP50) – ESD Safe

*Item Not Shown

SPARE PARTS LIST – QK-VTK

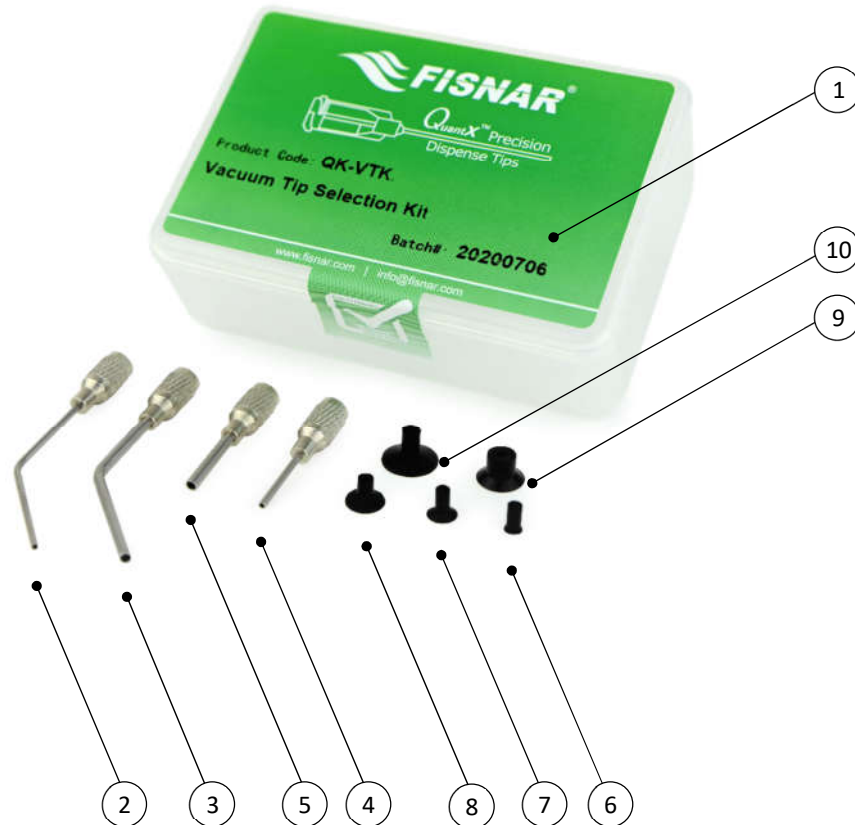

Ref.	Item Number	Description
1	QK-VTK	Vacuum Tip Selection Kit
2	580052	14ga 45° Vacuum Pickup Tip
3	580053	18ga 45° Vacuum Pickup Tip
4	5601942	14ga Vacuum Pickup Tip
5	5601941	18ga Vacuum Pickup Tip
6	580047	Vacuum Cup – 3mm
7	580048	Vacuum Cup – 4.75mm
8	580049	Vacuum Cup – 6.5mm
9	580050	Vacuum Cup – 8mm
10	580051	Vacuum Cup – 10mm

LIMITED WARRANTY

Manufacturer warrants this product to the original purchaser for a period of one (1) year from the date of purchase to be free from defects in material and workmanship, but not against damages caused by misuse, negligence, accident, faulty installation, abrasion, corrosion or by not operating in accordance with factory recommendations and instructions. Manufacturer will repair or replace (at factory's option), free of charge, any component of the equipment thus found to be defective, upon prepaid return of the equipment to the factory during the warranty period of the equipment. In no event shall any liability or obligation of Manufacturer arising from this warranty exceed the purchase price of the equipment. **This warranty is valid only when 5 micron filtered air is used.** The manufacturer's written liability, as stated herein, cannot be altered or enlarged except by a written statement signed by an officer of the company. In no event shall manufacturer be liable for consequential or incidental damages. A return authorization is required prior to shipping a defective machine to the factory.

Manufacturer reserves the right to make engineering or product modifications without notice.



info@fisnar.com

www.fisnar.com